

12V Cordless Auto-Hammer

68364 12V Cordless Auto-Hammer

WARNING

Read this material before using this product.
Failure to do so can result in serious injury.
Save this manual.



When unpacking, make sure that the product is intact and undamaged. If any parts are missing or broken, please call 1-800-444-3353 as soon as possible.

Visit our website at: <http://www.harborfreight.com>

Specifications

Charger Input	120 V~ / 60 Hz
Charging Time	3-5 Hours
Battery Type	12V, Ni-Cd, 800 mAh
Nail Size	2-1/2" Max. Length

Save This Manual

Keep this manual for the safety warnings and precautions, assembly, operating, inspection, maintenance and cleaning procedures. Write the product's serial number in the back of the manual near the assembly diagram (or month and year of purchase if product has no number). Keep this manual and the receipt in a safe and dry place for future reference.

Important Safety Information

In this manual, on the labeling, and all other information provided with this product:



This is the safety alert symbol. It is used to alert you to potential personal injury hazards. Obey all safety messages that follow this symbol to avoid possible injury or death.

DANGER

DANGER indicates a hazardous situation which, if not avoided, will result in death or serious injury.

WARNING

WARNING indicates a hazardous situation which, if not avoided, could result in death or serious injury.

CAUTION

CAUTION, used with the safety alert symbol, indicates a hazardous situation which, if not avoided, could result in minor or moderate injury.

NOTICE

NOTICE is used to address practices not related to personal injury.

CAUTION

CAUTION, without the safety alert symbol, is used to address practices not related to personal injury.

General Power Tool Safety Warnings



WARNING Read all safety warnings and instructions. *Failure to follow the warnings and instructions may result in electric shock, fire and/or serious injury.*

Save all warnings and instructions for future reference.

The term "power tool" in the warnings refers to your mains-operated (corded) power tool or battery-operated (cordless) power tool.

- 1. Work area safety**
 - a. Keep work area clean and well lit.** *Cluttered or dark areas invite accidents.*
 - b. Do not operate power tools in explosive atmospheres, such as in the presence of flammable liquids, gases or dust.** *Power tools create sparks which may ignite the dust or fumes.*
 - c. Keep children and bystanders away while operating a power tool.** *Distractions can cause you to lose control.*
- 2. Electrical safety**
 - a. Do not expose power tools to rain or wet conditions.** *Water entering a power tool will increase the risk of electric shock.*

3. Personal safety

- a. **Stay alert, watch what you are doing and use common sense when operating a power tool. Do not use a power tool while you are tired or under the influence of drugs, alcohol or medication.** *A moment of inattention while operating power tools may result in serious personal injury.*
- b. **Use personal protective equipment. Always wear eye protection.** *Safety equipment such as dust mask, non-skid safety shoes, hard hat, or hearing protection used for appropriate conditions will reduce personal injuries.*
- c. **Prevent unintentional starting. Ensure the switch is in the off-position before connecting to power source and/or battery pack, picking up or carrying the tool.** *Carrying power tools with your finger on the switch or energizing power tools that have the switch on invites accidents.*
- d. **Remove any adjusting key or wrench before turning the power tool on.** *A wrench or a key left attached to a rotating part of the power tool may result in personal injury.*
- e. **Do not overreach. Keep proper footing and balance at all times.** *This enables better control of the power tool in unexpected situations.*
- f. **Dress properly. Do not wear loose clothing or jewelry. Keep your hair, clothing and gloves away from moving parts.** *Loose clothes, jewelry or long hair can be caught in moving parts.*
- g. **If devices are provided for the connection of dust extraction and collection facilities, ensure these are connected and properly used.** *Use of these devices can reduce dust-related hazards.*
- h. **Only use safety equipment that has been approved by an appropriate standards agency.** *Unapproved safety equipment may not provide adequate protection. Eye protection must be ANSI-approved and breathing protection must be NIOSH-approved for the specific hazards in the work area.*

4. Power tool use and care

- a. **Do not force the power tool. Use the correct power tool for your application.** *The correct power tool will do the job better and safer at the rate for which it was designed.*
- b. **Do not use the power tool if the switch does not turn it on and off.** *Any power tool that cannot be controlled with the switch is dangerous and must be repaired.*
- c. **Disconnect the plug from the power source and/or the battery pack from the power tool before making any adjustments, changing accessories, or storing power tools.** *Such preventive safety measures reduce the risk of starting the power tool accidentally.*

- d. **Store idle power tools out of the reach of children and do not allow persons unfamiliar with the power tool or these instructions to operate the power tool.** *Power tools are dangerous in the hands of untrained users.*
- e. **Maintain power tools. Check for misalignment or binding of moving parts, breakage of parts and any other condition that may affect the power tool's operation. If damaged, have the power tool repaired before use.** *Many accidents are caused by poorly maintained power tools.*
- f. **Keep cutting tools sharp and clean.** *Properly maintained cutting tools with sharp cutting edges are less likely to bind and are easier to control.*
- g. **Use the power tool, accessories and tool bits etc. in accordance with these instructions, taking into account the working conditions and the work to be performed.** *Use of the power tool for operations different from those intended could result in a hazardous situation.*



5. Battery tool use and care

- a. **Recharge only with the charger specified by the manufacturer.** *A charger that is suitable for one type of battery pack may create a risk of fire when used with another battery pack.*
- b. **Use power tools only with specifically designated battery packs.** *Use of any other battery packs may create a risk of injury and fire.*
- c. **When battery pack is not in use, keep it away from other metal objects, like paper clips, coins, keys, nails, screws or other small metal objects, that can make a connection from one terminal to another.** *Shorting the battery terminals together may cause burns or a fire.*
- d. **Under abusive conditions, liquid may be ejected from the battery; avoid contact. If contact accidentally occurs, flush with water. If liquid contacts eyes, additionally seek medical help.** *Liquid ejected from the battery may cause irritation or burns.*

6. Service

- a. **Have your power tool serviced by a qualified repair person using only identical replacement parts.** *This will ensure that the safety of the power tool is maintained.*

Auto Hammer Safety Warnings

1.  **Wear hearing protection during use; Auto Hammer is loud during operation.**
2. **Do not use Auto Hammer with nails longer than 2-1/2".**
3. **Do not leave Auto Hammer unattended during charging.**
4. **Use as intended only. Use to hammer nails into the following materials only: wood, wood-like materials and plaster board.**
5. **Hold power tools by insulated gripping surfaces when performing an operation where the cutting tool may contact hidden wiring.**
Contact with a "live" wire will make exposed metal parts of the tool "live" and shock the operator.
6. Maintain labels and nameplates on the tool. These carry important safety information. If unreadable or missing, contact Harbor Freight Tools for a replacement.
7. Avoid unintentional starting. Prepare to begin work before turning on the tool.
8. Do not lay the tool down until it has come to a complete stop. Moving parts can grab the surface and pull the tool out of your control.
9. When using a handheld power tool, maintain a firm grip on the tool with both hands to resist starting torque.
10. Do not leave the tool unattended when it is plugged into an electrical outlet. Turn off the tool, and unplug it from its electrical outlet before leaving.
11.  The battery charger gets hot during use. The charger's heat can build up to unsafe levels and create a fire hazard if it does not receive adequate ventilation, due to an electrical fault, or if it is used in a hot environment. Do not place the charger on a flammable surface. Do not obstruct any vents on the charger. **Especially avoid placing the charger on carpets and rugs; they are not only flammable, but they also obstruct vents under the charger.**
Place the charger on a stable, solid, nonflammable surface (such as a stable metal workbench or concrete floor) at least 1 foot away from all flammable objects, such as drapes or walls. Keep a fire extinguisher and a smoke detector in the area. Frequently monitor the charger and battery while charging.
12. This product is not a toy. Keep it out of reach of children.
13. People with pacemakers should consult their physician(s) before use. Electromagnetic fields in close proximity to heart pacemaker could cause pacemaker interference or pacemaker failure. In addition, people with pacemakers should:
 - Avoid operating alone.
 - Do not use with power switch locked on.
 - Properly maintain and inspect to avoid electrical shock.
14. **WARNING:** Some dust created by power sanding, sawing, grinding, drilling, and other construction activities, contains chemicals known [to the State of California] to cause cancer, birth defects or other reproductive harm. Some examples of these chemicals are:
 - Lead from lead-based paints
 - Crystalline silica from bricks and cement or other masonry products
 - Arsenic and chromium from chemically treated lumberYour risk from these exposures varies, depending on how often you do this type of work. To reduce your exposure to these chemicals: work in a well ventilated area, and work with approved safety equipment, such as those dust masks that are specially designed to filter out microscopic particles.
(California Health & Safety Code § 25249.5, *et seq.*)
15. **WARNING:** Handling the cord on this product's charger will expose you to lead, a chemical known to the State of California to cause cancer, and birth defects or other reproductive harm. Wash hands after handling.
(California Health & Safety Code § 25249.5, *et seq.*)
16. The warnings, precautions, and instructions discussed in this instruction manual cannot cover all possible conditions and situations that may occur. It must be understood by the operator that common sense and caution are factors which cannot be built into this product, but must be supplied by the operator.

Vibration Safety

This tool vibrates during use. Repeated or long-term exposure to vibration may cause temporary or permanent physical injury, particularly to the hands, arms and shoulders. To reduce the risk of vibration-related injury:

1. Anyone using vibrating tools regularly or for an extended period should first be examined by a doctor and then have regular medical check-ups to ensure medical problems are not being caused or worsened from use. Pregnant women or people who have impaired blood circulation to the hand, past hand injuries, nervous system disorders, diabetes, or Raynaud's Disease should not use this tool. If you feel any symptoms related to vibration (such

as tingling, numbness, and white or blue fingers), seek medical advice as soon as possible.

2. Do not smoke during use. Nicotine reduces the blood supply to the hands and fingers, increasing the risk of vibration-related injury.
3. Wear suitable gloves to reduce the vibration effects on the user.
4. Use tools with the lowest vibration when there is a choice.
5. Include vibration-free periods each day of work.
6. Grip tool as lightly as possible (while still keeping safe control of it). Let the tool do the work.
7. To reduce vibration, maintain the tool as explained in this manual. If any abnormal vibration occurs, stop use immediately.

SAVE THESE INSTRUCTIONS.

Grounding

WARNING



TO PREVENT ELECTRIC SHOCK AND DEATH FROM INCORRECT GROUNDING WIRE CONNECTION: Check with a qualified electrician if you are in doubt as to whether the outlet is properly grounded. Do not modify the power cord plug provided with the tool. Never remove the grounding prong from the plug. Do not use the tool if the power cord or plug is damaged. If damaged, have it repaired by a service facility before use. If the plug will not fit the outlet, have a proper outlet installed by a qualified electrician.

Double Insulated Tools: Tools with Two Prong Plugs

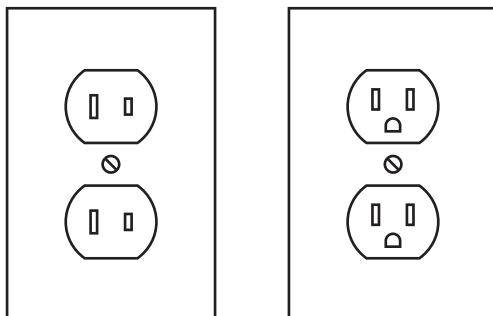











Outlets for 2-Prong Plug

1. Tools marked “Double Insulated” do not require grounding. They have a special double insulation system which satisfies OSHA requirements and complies with the applicable standards of Underwriters Laboratories, Inc., the Canadian Standard Association, and the National Electrical Code.
2. Double insulated tools may be used in either of the 120 volt outlets shown in the preceding illustration. **(See Outlets for 2-Prong Plug.)**

Extension Cords

Note: Extension cords must not be used with this item’s charger.

Symbology

	Double Insulated
	Canadian Standards Association
	Underwriters Laboratories, Inc.
	Volts Alternating Current
	Amperes
n_0 xxxx/min.	No Load Revolutions per Minute (RPM)
	WARNING marking concerning Risk of Eye Injury. Wear ANSI-approved safety goggles with side shields.
	Read the manual before set-up and/or use.
	WARNING marking concerning Risk of Hearing Loss. Wear hearing protection.
	WARNING marking concerning Risk of Fire. Do not cover ventilation ducts. Keep flammable objects away.
	WARNING marking concerning Risk of Electric Shock. Properly connect power cord to appropriate outlet.

Functions



Read the **ENTIRE IMPORTANT SAFETY INFORMATION** section at the beginning of this manual including all text under subheadings therein before set up or use of this product.

⚠️ WARNING

TO PREVENT SERIOUS INJURY FROM ACCIDENTAL OPERATION:

Release the Trigger and disconnect Battery Pack before assembling or making any adjustments to the tool.

Note: For additional information regarding the parts listed in the following pages, refer to *Parts List and Assembly Diagram* on page 11.



Operating Instructions



Read the **ENTIRE IMPORTANT SAFETY INFORMATION** section at the beginning of this manual including all text under subheadings therein before set up or use of this product.

Tool Set Up

⚠️WARNING

TO PREVENT SERIOUS INJURY FROM ACCIDENTAL OPERATION:

Release the Trigger and disconnect Battery Pack before adjusting tool or installing accessories.

Work Piece and Work Area Set Up

1. Designate a work area that is clean and well-lit. The work area must not allow access by children or pets to prevent distraction and injury.
2. Route the power cord along a safe route to reach the work area without creating a tripping hazard or exposing the power cord to possible damage. The power cord must reach the work area with enough extra length to allow free movement while working.
3. Secure loose work pieces using a vise or clamps (not included) to prevent movement while working.
4. There must not be objects, such as utility lines, nearby that will present a hazard while working.

Charging

1. Place the Battery Pack on a dry fireproof surface in a room where the temperature is from 50–104° F.

Note: If recharging a newly spent Battery Pack, allow it to cool completely before charging.

Make sure the Battery Pack is undamaged; do not charge a cracked or leaking battery pack.

2. Disconnect the Cord from the Battery Charger. Attach the Adapter plug to a grounded, 120 V~, 60 Hz outlet.
3. Plug the Charger into the power supply. The red light on the Charger will light, showing that power is supplied to the Charger.
4. **IMPORTANT:** When Battery is fully charged, the red light will **continue** to stay lit. **WARNING!** **Do not leave unattended while charging.**

Note: The Battery Pack's capacity will increase somewhat during the first few charging cycles. A fully discharged battery will take about 3 to 5

hours to fully charge. **CAUTION!** Recharging the Battery Pack for more than 5 hours can damage the battery cells. Keep track of charging time.

5. While charging, the Battery Pack and Charger, and Adapter may become warm to the touch. This is normal, and does not indicate a problem.
6. Unplug the Charger and disconnect it from the Battery Pack when finished.
7. Allow the Battery Pack to cool completely before using it.
8. Press the Battery Tabs to release Battery Pack from the Charger (or when removing it from the Auto Hammer).
9. Store the Charger and Battery Pack indoors, out of reach of children. **WARNING!** Do NOT use a different Charger or Battery to power this Auto Hammer.

General Operating Instructions

⚠️WARNING

TO PREVENT SERIOUS INJURY FROM ACCIDENTAL OPERATION:

Release the Trigger and disconnect Battery Pack before adjusting tool or installing accessories.

- **DO NOT** install the Battery Pack until **AFTER** you complete the following steps to set up the Auto Hammer for use.
- Refer to page 6 for the location of the parts of the Auto Hammer for the following steps.

1. The Auto Hammer is designed to accept up to 2-1/2" long nails. Do not use larger nails with this Auto Hammer as damage to the tool, nail or workpiece may occur. Only use to hammer nails into wood, drywall and/or particle board.

CAUTION: This tool is not intended for framing or other heavy-duty applications. Larger 2-1/2" nails may take longer to completely drive, especially in harder wood.

WARNING! Do not use Auto Hammer for hammering nails into metal or concrete.

2. To load nails, hold the Auto Hammer firmly and keep your fingers away from the Trigger.
3. With the Auto Hammer's nose pointed away from you, feed a nail into the magnetic sleeve. The sleeve will hold the nail in place until you are ready to drive the nail into the workpiece.

WARNING! Keep the Auto Hammer pointed away from yourself and others when loading nail. Do not load nail while pressing the Trigger.

- Once the nail is loaded, secure the workpiece with clamps.

CAUTION: Use a scrap piece of wood to test the potential of marring your workpiece when using finish nails.

- Use your free hand to steady the point of the nail at the desired location on the workpiece.

WARNING! Wear ANSI-approved safety goggles, heavy-duty work gloves, and hearing protection.

- Press the Trigger, applying enough force to partially drive the nail into the workpiece (far enough into the workpiece so that the nail does not wobble.)

- Move your hand away from the nail before activating the Auto Hammer again.

- Press the Trigger again and continue to do so until the nail head is flush with the workpiece.

WARNING! Do not force the tool or apply side pressure with your free hand. Use only one hand to hold the tool during use.

- During use, avoid hammering nails into knots in wood or similar grain patterns. Doing so can make it difficult for the Auto Hammer to drive the nails.

WARNING! Do not place your hand or fingers near the nail head while the tool is hammering. Use your hand to hold the nail only during the initial firing.

- Avoid driving nails close to the edges of the workpiece. This can cause the wood to splinter or split.

- Be careful when driving nails close to the edge of the workpiece. Driving the nail too far can damage the workpiece.

- When finished using the Auto Hammer, release the Trigger.

- Remove the Battery Pack.

- Clean then store the Auto Hammer indoors and out of children's reach.

Maintenance and Servicing



Procedures not specifically explained in this manual must be performed only by a qualified technician.

WARNING

TO PREVENT SERIOUS INJURY FROM ACCIDENTAL OPERATION:

Release the Trigger and disconnect Battery Pack before performing any inspection, maintenance, or cleaning procedures.

TO PREVENT SERIOUS INJURY FROM TOOL FAILURE:

Do not use damaged equipment. If abnormal noise or vibration occurs, have the problem corrected before further use.

Cleaning, Maintenance, and Lubrication

- BEFORE EACH USE**, inspect the general condition of the tool. Check for loose hardware, misalignment or binding of moving parts, cracked or broken parts, damaged electrical wiring, and any other condition that may affect its safe operation.

- AFTER USE**, wipe external surfaces of the tool with clean cloth.

NOTE: Ni-Cd BATTERY MUST BE RECYCLED OR DISPOSED OF PROPERLY. Do not short, incinerate or open Battery Pack.

- When storing, always store in clean, dry and safe location out of reach of children.

- WARNING!** If the supply cord of this power tool's charger is damaged, it must be replaced only by a qualified service technician.

Troubleshooting

Problem	Possible Causes	Likely Solutions
Tool will not start.	<ol style="list-style-type: none"> 1. No power at outlet during charging. 2. Internal damage or wear. (Carbon brushes or switch, for example.) 	<ol style="list-style-type: none"> 1. Check power at outlet. If outlet is unpowered, turn off tool and check circuit breaker. If breaker is tripped, make sure circuit is right capacity for tool and circuit has no other loads. 2. Have technician service tool.
Excessive noise or rattling.	Internal damage or wear. (Carbon brushes or bearings, for example.)	Have technician service tool.
Overheating.	<ol style="list-style-type: none"> 1. Forcing tool to work too fast. 2. Accessory misaligned. 3. Accessory dull or damaged. 	<ol style="list-style-type: none"> 1. Allow tool to work at its own rate. 2. Check and correct accessory. 3. Keep cutting accessories sharp. Replace as needed.
 Follow all safety precautions whenever diagnosing or servicing the tool. Disconnect power supply before service.		

Parts List and Assembly Diagram

PLEASE READ THE FOLLOWING CAREFULLY

THE MANUFACTURER AND/OR DISTRIBUTOR HAS PROVIDED THE PARTS LIST AND ASSEMBLY DIAGRAM IN THIS MANUAL AS A REFERENCE TOOL ONLY. NEITHER THE MANUFACTURER OR DISTRIBUTOR MAKES ANY REPRESENTATION OR WARRANTY OF ANY KIND TO THE BUYER THAT HE OR SHE IS QUALIFIED TO MAKE ANY REPAIRS TO THE PRODUCT, OR THAT HE OR SHE IS QUALIFIED TO REPLACE ANY PARTS OF THE PRODUCT. IN FACT, THE MANUFACTURER AND/OR DISTRIBUTOR EXPRESSLY STATES THAT ALL REPAIRS AND PARTS REPLACEMENTS SHOULD BE UNDERTAKEN BY CERTIFIED AND LICENSED TECHNICIANS, AND NOT BY THE BUYER. THE BUYER ASSUMES ALL RISK AND LIABILITY ARISING OUT OF HIS OR HER REPAIRS TO THE ORIGINAL PRODUCT OR REPLACEMENT PARTS THERETO, OR ARISING OUT OF HIS OR HER INSTALLATION OF REPLACEMENT PARTS THERETO.

Parts List

Part	Description	Qty.
1	Housing	1
2	Screw (ST2.9x16)	5
3	Battery Pack	1
4	Battery Terminal	1
5	Gear Case & Motor	1
6	Switch	1
7	Wire	4
8	Lock Ring	1
9	Screw (ST2.9x12)	3
10	Trigger	1
11	LED	1
12	Upper Housing	1
13	Bearing (6900Z)	1
14	Circlip (1x19x25)	1
15	Gear Shaft	1
16	Needle Bearing (8800Z)	1
17	Bearing (697Z)	1
18	Transmission Gear	1
19	Motor Gear	1
20	Motor Screw (M3x10)	1
21	Motor Bearing	1
22	Motor Bracket	1

Part	Description	Qty.
23	Motor	1
24	Lower Housing	1
25	Screw (ST2.9x12)	12
26	Impact Cover	1
27	Press Spring (1x19x25)	1
28	Sealing Ring (6x2)	1
29	Impactor	1
30	Press Spring Ring	2
31	Press Spring	1
32	Impact Sheath	1
33	Magnetic Block	1
34	Magnetic Cover	1
35	Head Screws	1
36	Pin	3
37	Bearing (607Z)	1
38	Impact Plate	1
39	Impact Block	1
40	Balance Block	1
41	Tension Spring	1
42	Main Shaft	1
43	Flat Key	1
44	Gear Plate	1

Record Product's Serial Number Here: _____

Note: If product has no serial number, record month and year of purchase instead.

Note: Some parts are listed and shown for illustration purposes only, and are not available individually as replacement parts.

Parts List and Assembly Diagram

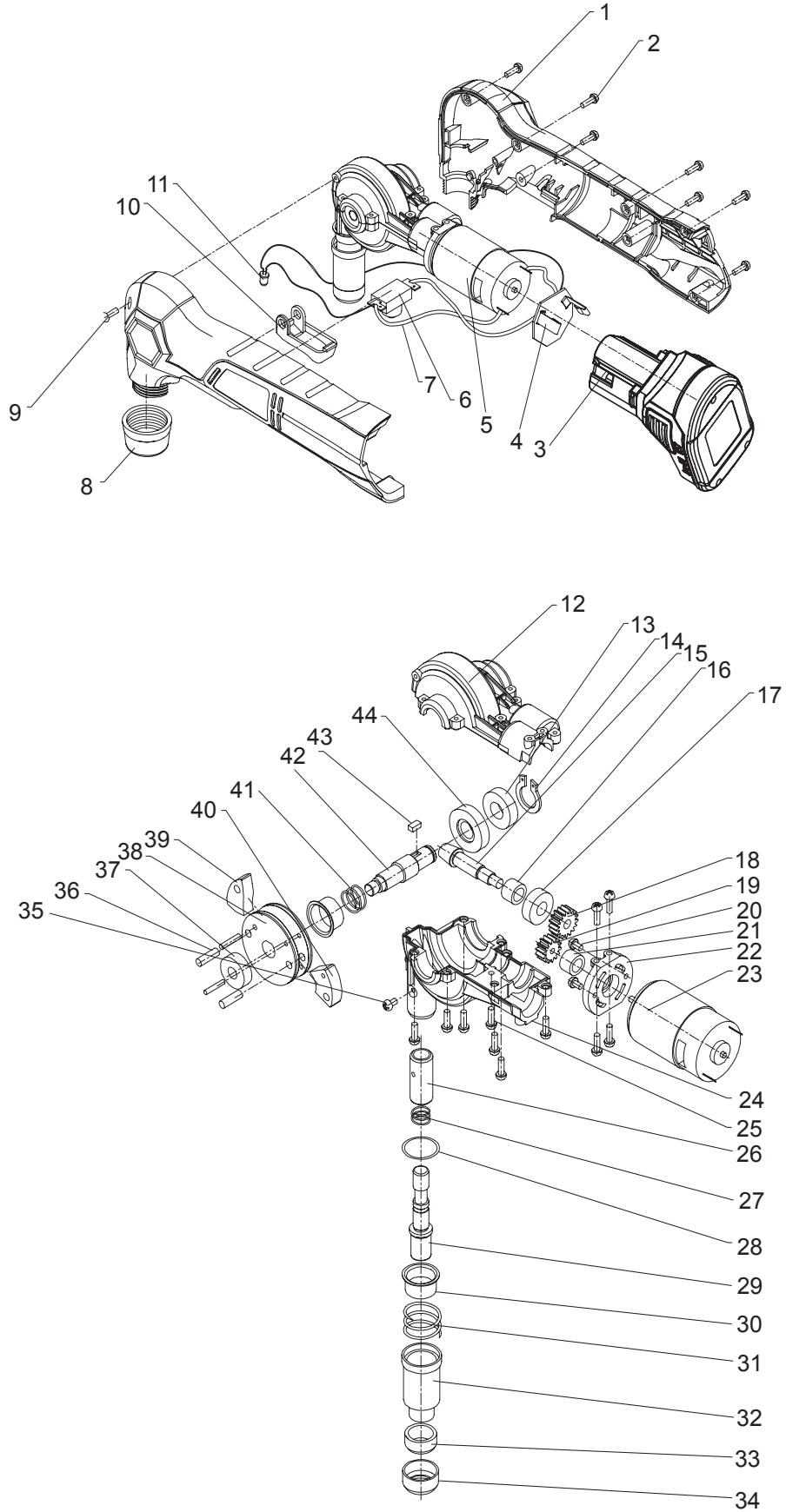

Warranty

Harbor Freight Tools Co. makes every effort to assure that its products meet high quality and durability standards, and warrants to the original purchaser that this product is free from defects in materials and workmanship for the period of 90 days from the date of purchase. This warranty does not apply to damage due directly or indirectly, to misuse, abuse, negligence or accidents, repairs or alterations outside our facilities, criminal activity, improper installation, normal wear and tear, or to lack of maintenance. We shall in no event be liable for death, injuries to persons or property, or for incidental, contingent, special or consequential damages arising from the use of our product. Some states do not allow the exclusion or limitation of incidental or consequential damages, so the above limitation of exclusion may not apply to you. **THIS WARRANTY IS EXPRESSLY IN LIEU OF ALL OTHER WARRANTIES, EXPRESS OR IMPLIED, INCLUDING THE WARRANTIES OF MERCHANTABILITY AND FITNESS.**

To take advantage of this warranty, the product or part must be returned to us with transportation charges prepaid. Proof of purchase date and an explanation of the complaint must accompany the merchandise. If our inspection verifies the defect, we will either repair or replace the product at our election or we may elect to refund the purchase price if we cannot readily and quickly provide you with a replacement. We will return repaired products at our expense, but if we determine there is no defect, or that the defect resulted from causes not within the scope of our warranty, then you must bear the cost of returning the product.

This warranty gives you specific legal rights and you may also have other rights which vary from state to state.

**CHICAGO  ELECTRIC®
POWER TOOLS**

3491 Mission Oaks Blvd. • PO Box 6009 • Camarillo, CA 93011 • (800) 444-3353